

# SHERMAN TANK



284PIECES



x1





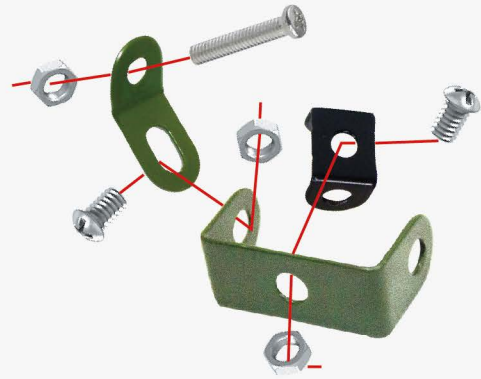

6029x1

# 01

-  x1
-  x1
-  x1
-  c20x1
-  x2
-  x3







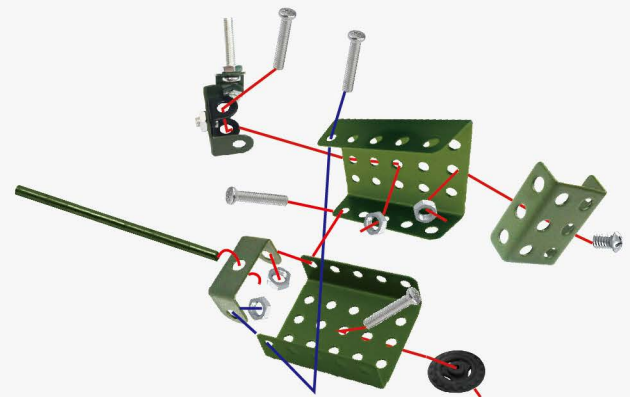

# 02

-  x1
-  x1
-  x2
-  x1
-  x1
-  c20x4
-  x1
-  x4







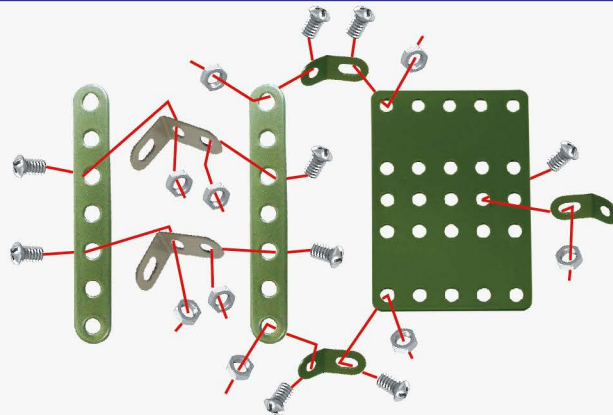

### 03

-  x3
-  x1
-  x2
-  x2
-  x9
-  x9



### 04

-  x2
-  x2
-  x3
-  x2
-  x1
-  x11
-  x11

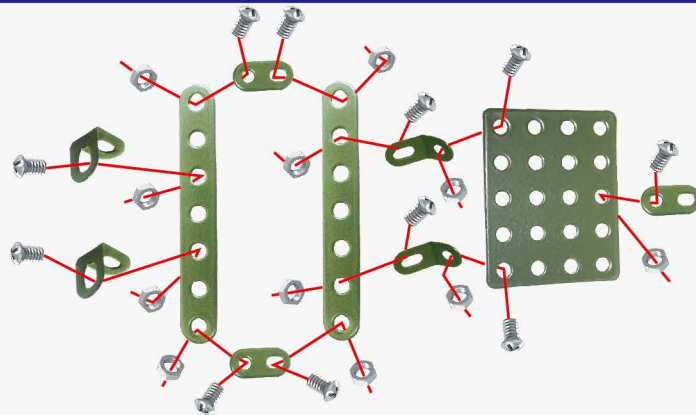

05



x2



x8



x2



x8



x3

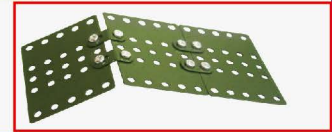
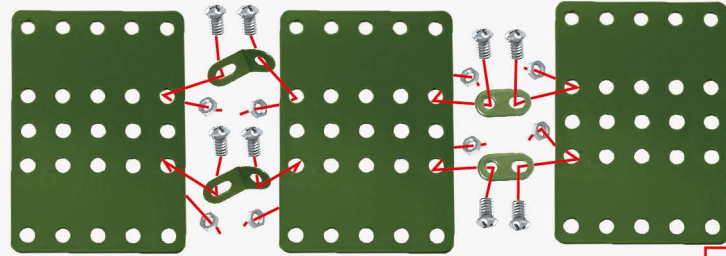

06



x10



c20x10



x4



x10



x2

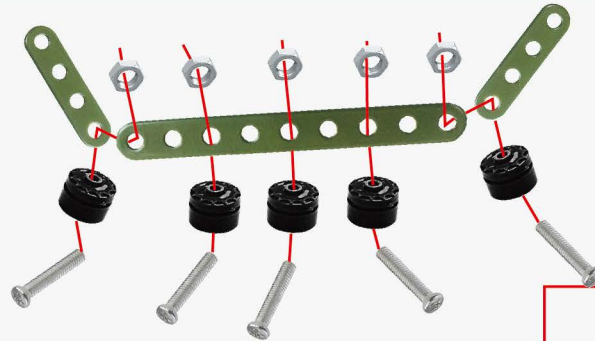

x2





07

 x12    x2

 x2    x2

 x2    x2

 x2    x12

 x2

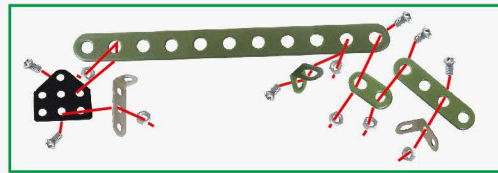
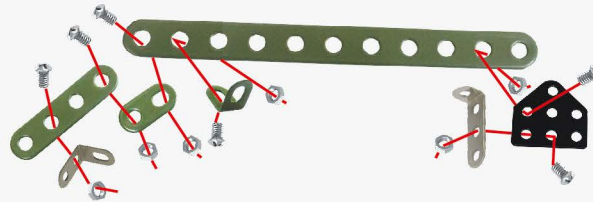





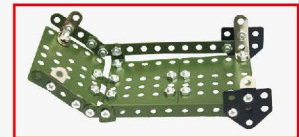
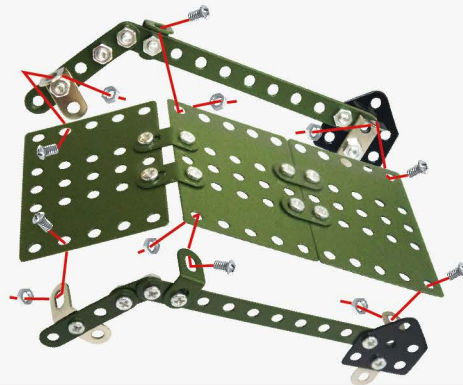

08

 x6

 x6



# 09



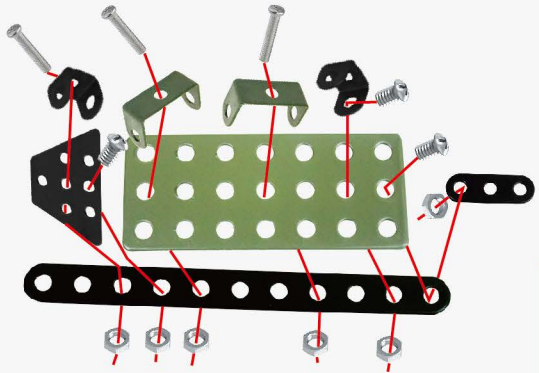

-  x12
-  x4
-  x4
-  x2
-  x2
-  c20x6
-  x2
-  x6
-  x2



x2



# 10

-  x4
-  x8
-  x8
-  x2

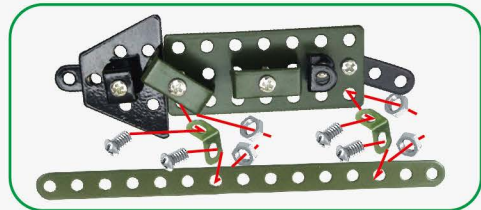
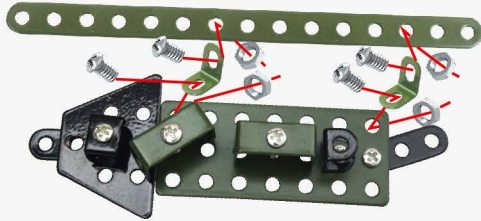

11

 x4

 c20x4

 x4

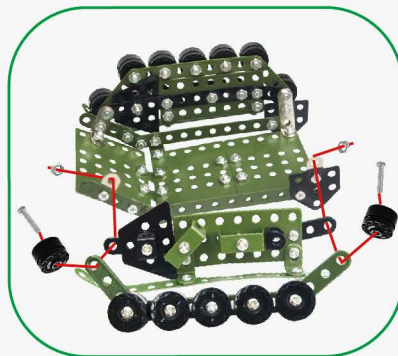
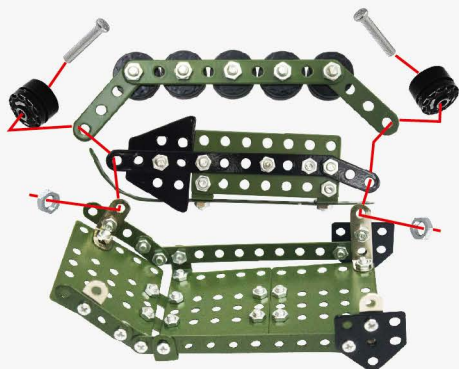

12

 x4

 x4

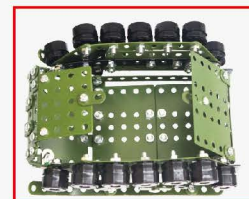
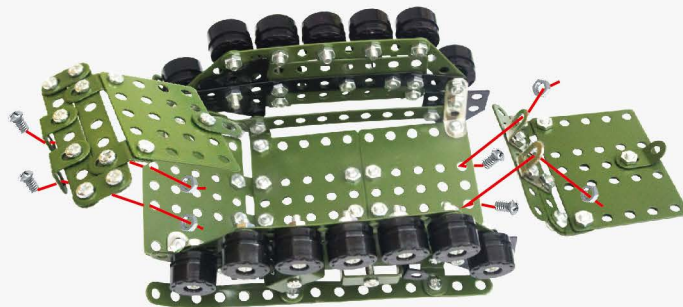

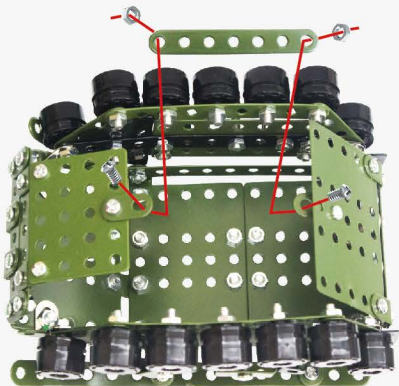

13

-  x2
-  x2
-  x1



14

-  x1
-  x1
-  x2

