

SPORTS CAR



169PCS



JY-Z7 **x1**



JR-Z4 **x2**



JY-LG1 **x4**



JY-Z5 **x1**

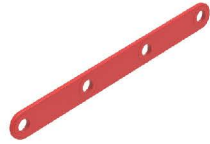

JR-Z4 **x1**



JR-LT1 **x4**



JY-Z3 **x1**



JR-Z2 **x2**



JP-LM **x54**



JY-Z2 **x3**



JY-W1 **x2**



JP-LS1 **x47**



JY-2C7 **x4**



JR-T4 **x1**



JP-LS2 **x2**



JY-C4 **x4**



JR-T3 **x4**



JP-LS3 **x4**



JY-C2 **x3**



JR-Y2 **x5**



JP-Y1 **x2**



JY-Q3 **x1**



JY-Z2B **x3**



JY-Q1 **x12**

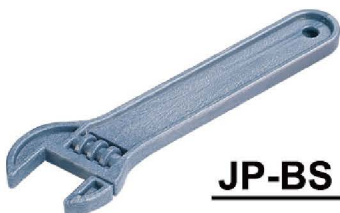







JP-BS **x1**





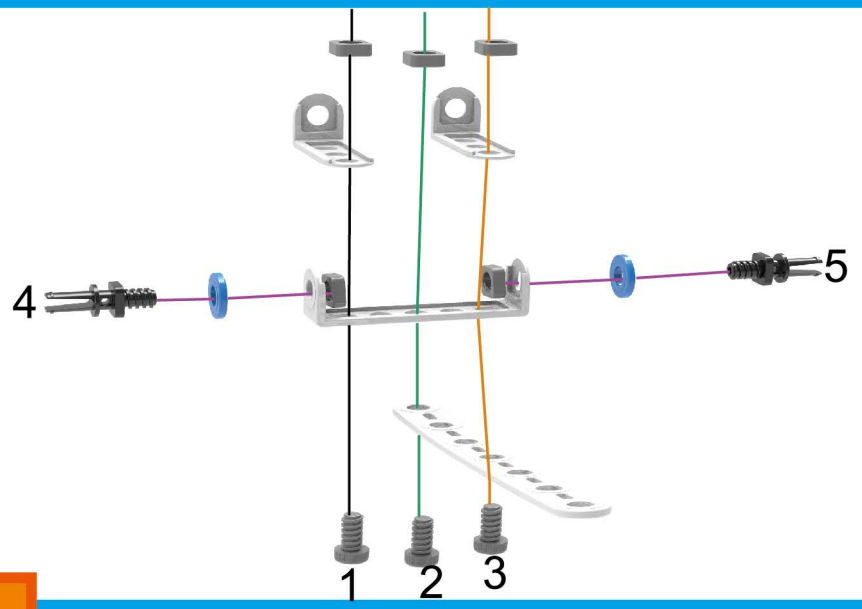

JP-LSD **x1**

1

-  x2
-  x3
-  x2
-  x5
-  x2
-  x1
-  x1







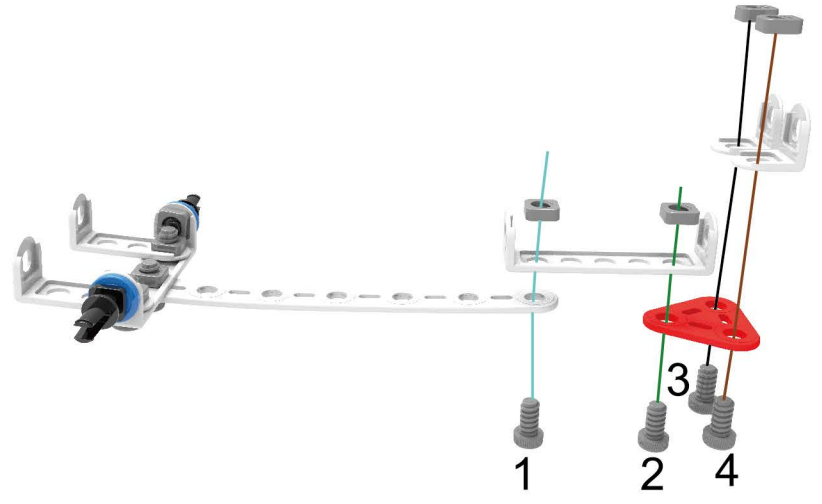

2

-  x2
-  x1
-  x1
-  x4
-  x4





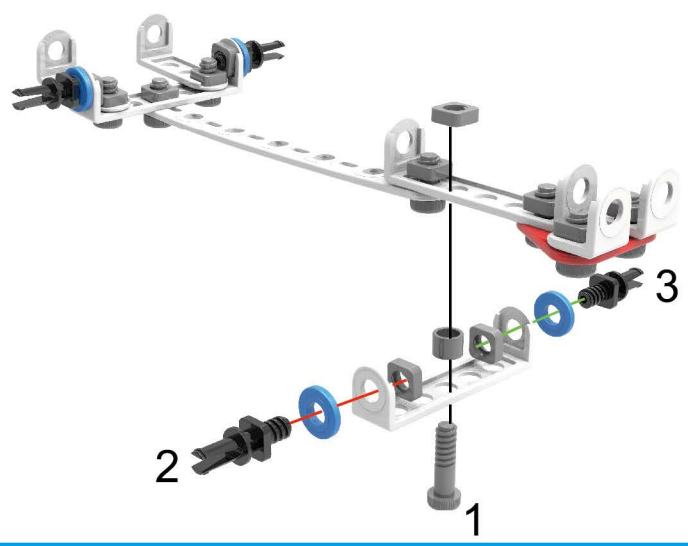

3

-  x1
-  x2
-  x3
-  x2
-  x1
-  x1



4



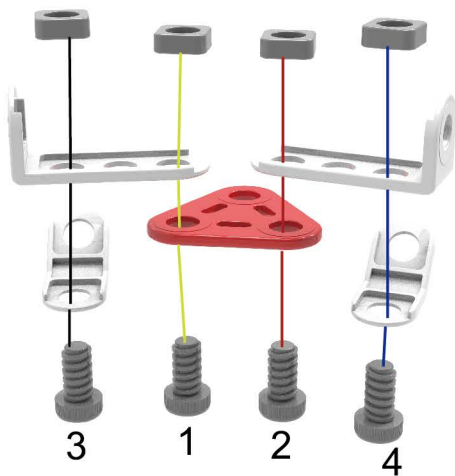

-  x4
-  x4
-  x2
-  x2
-  x1

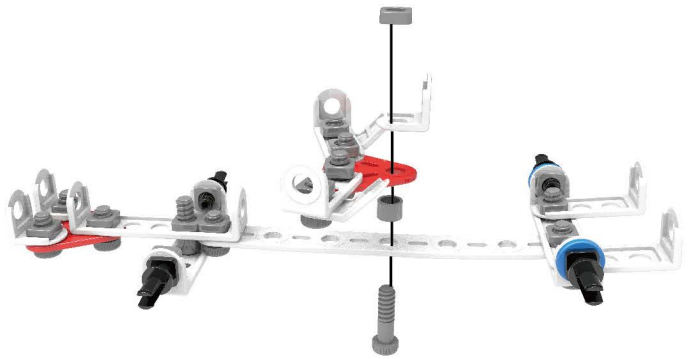

-  x1
-  x1
-  x1
-  x1
-  x1





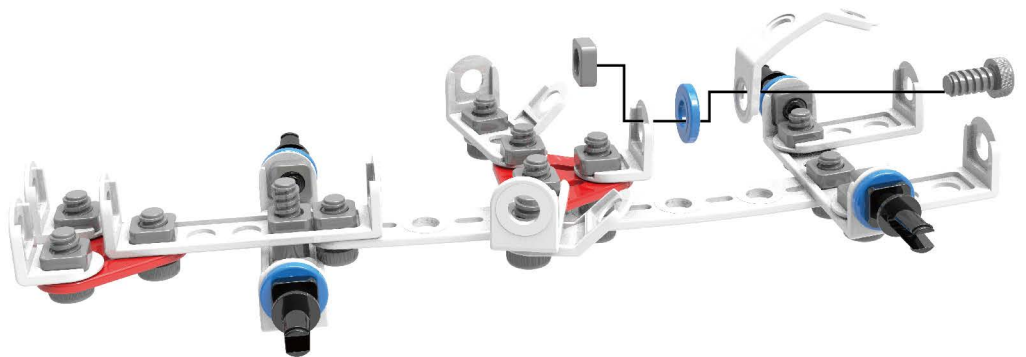

5

-  x1
-  x1
-  x1
-  x1







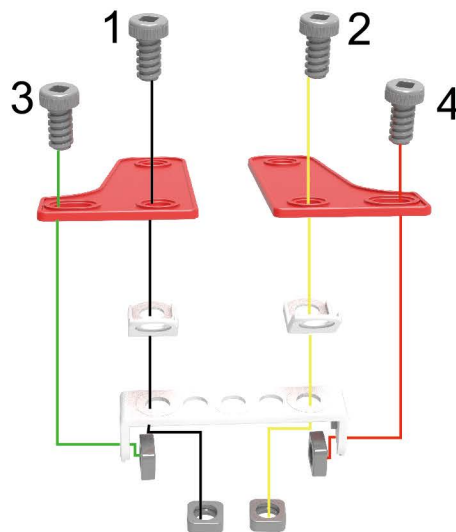

6

-  x4
-  x4
-  x1
-  x2
-  x2



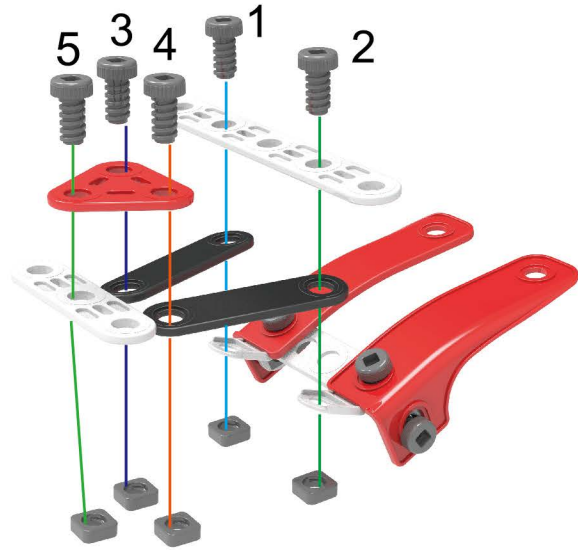

7

-  x5
-  x1
-  x5
-  x2
-  x1
-  x1



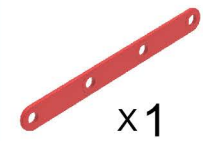

8

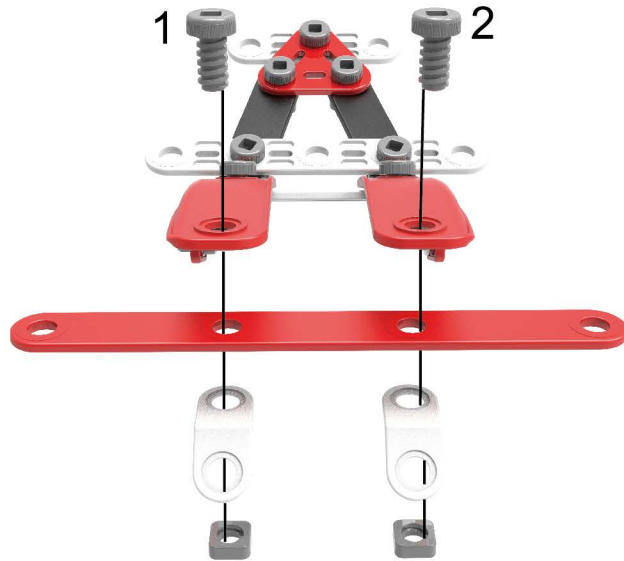
-  x2
-  x2
-  x2
-  x1



9

-  x1
-  x4
-  x2
-  x4

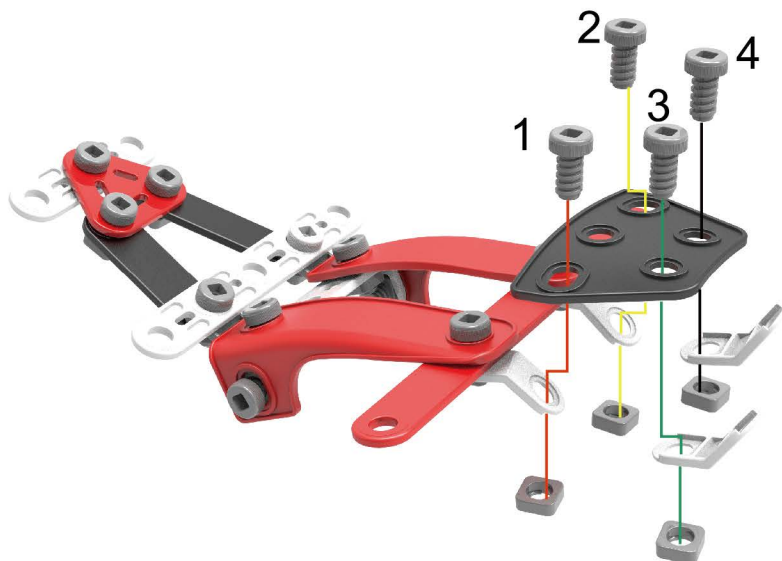



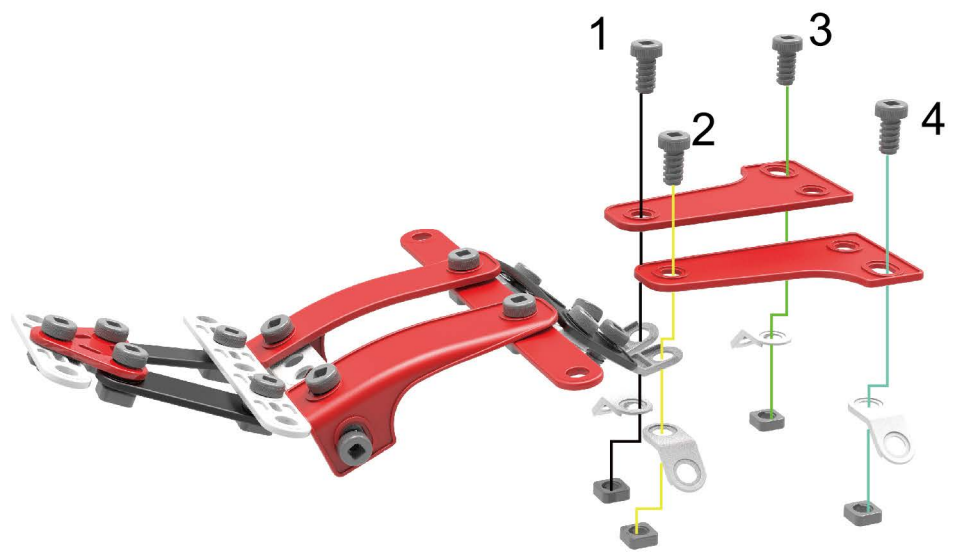

10

-  x 4
-  x 4
-  x 4
-  x 2



11

-  x 2
-  x 1
-  x 2
-  x 1
- 



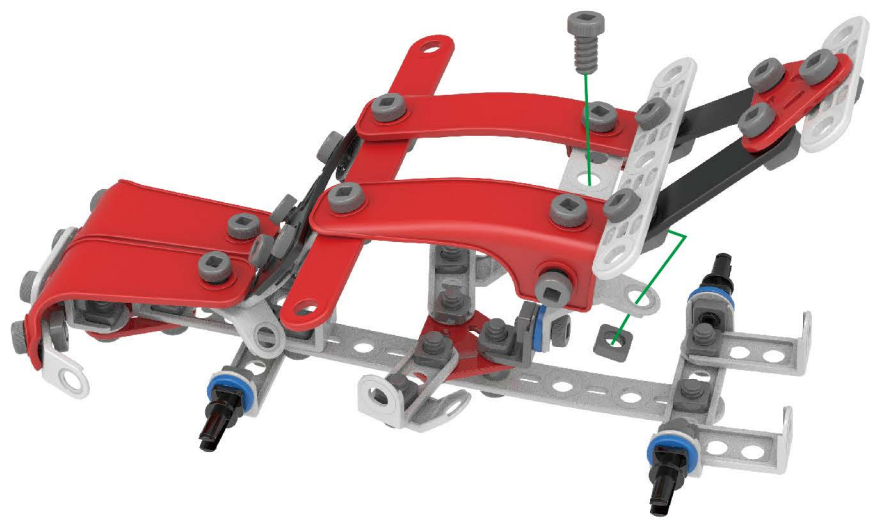

12

-  x 1
-  x 1



13

-  x2
-  x2
-  x2

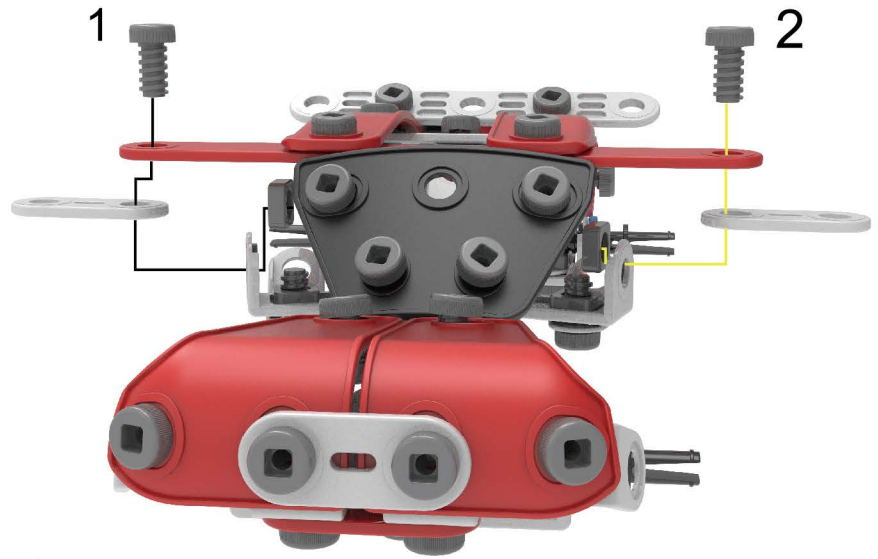

14

-  x2
-  x2
-  x1

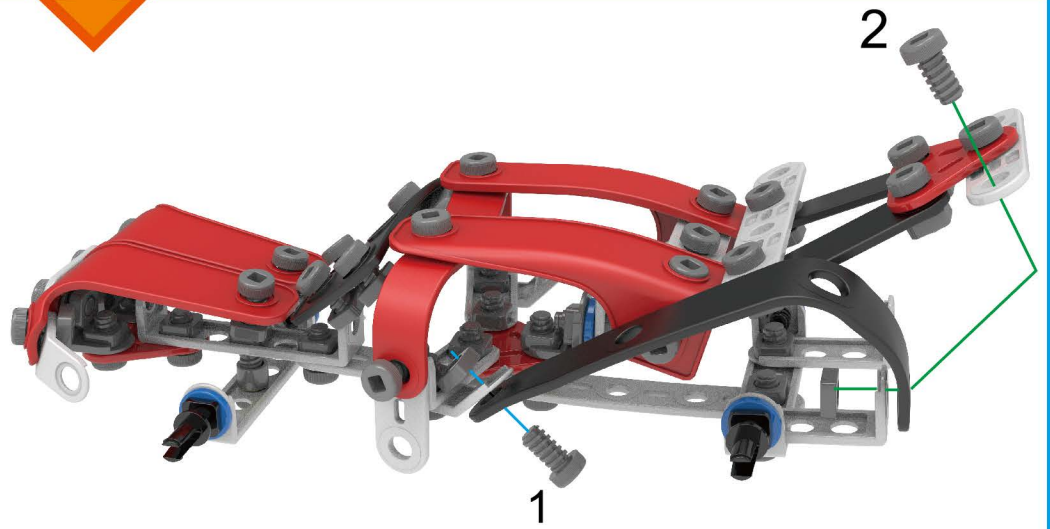

15

-  x2
-  x2
-  x1

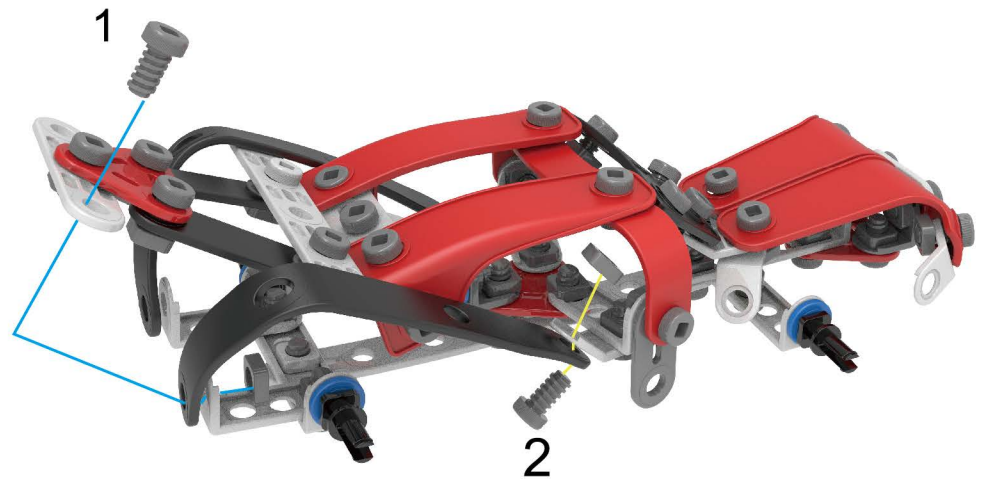

16

 x3

 x3

 x1

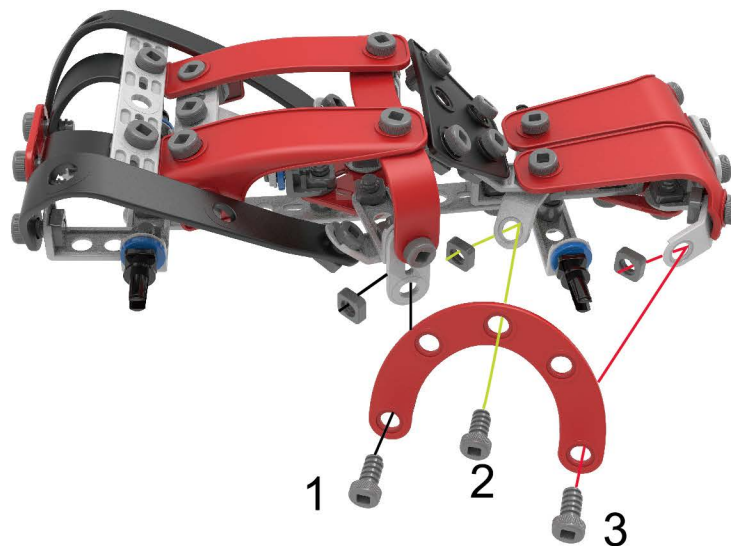

17

 x3

 x3

 x1

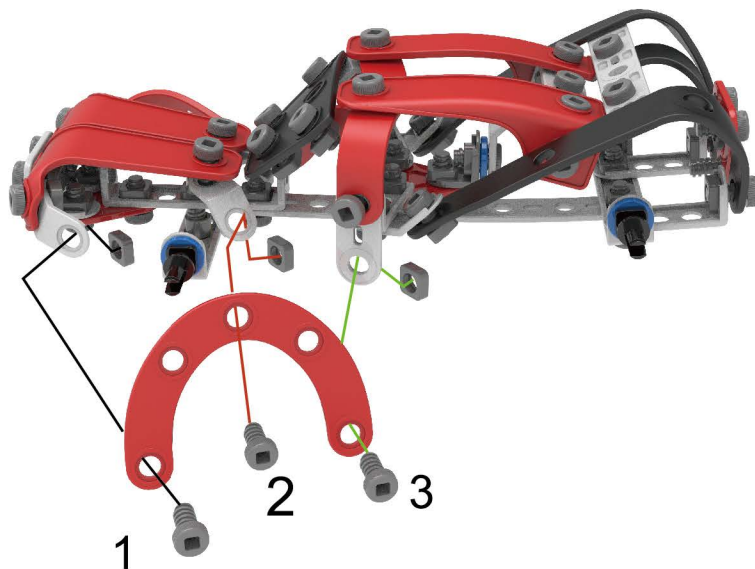

18

 x4

 x4

